

# Bass Extension - double coil - digitally powered **TSMini Sub dc dp**



Active bass extension for the TSMini or TSNano. Integrated digitally controlled amplifier (class D, 2 x 500 Watt) and stereo passive crossover for the mid / high systems. The precision and power handling capacity of this very compact system are due to the long excursion long excursion, high power Neodym woofer which features an extra long 32 mm coil with a 100 mm diameter.

## PRODUCT SPECIFICATIONS

<b>Speaker Components</b>	12" Nd
<b>Description</b>	Digitally Powered Bass Extension
<b>Amp Power</b>	1000 W EIAJ / 195-250 V
<b>Rated Current</b>	2,3 A @ 230 V
<b>SPL</b> <small>Peak @ 1 m</small>	127 dB
<b>Max. Input Signal</b>	15 dBu
<b>DSP</b>	- - - *
<b>Usable Range</b> <small>- 6 dB</small>	40 Hz - 150 Hz
<b>Tuning Frequency</b> <small>excursion minimum</small>	48 Hz
<b>Connectors</b>	2 x Neutrik XLR in 2 x Neutrik Speakon out Neutrik PowerCon in
<b>Handles</b>	2 x
<b>Rigging / Fittings</b>	M20 on top
<b>Weight</b>	25,0 kg
<b>Size</b> <small>height x width x depth</small>	44,0 x 40,0 x 44,0 cm
<b>Order No.</b>	<b>00992/dc/dp</b>

\* passive X-Over (12 dB / oct.)  
X-Overpoint 145 Hz with TS Mini



Two large bar handles for easy handling.



Connection panel.

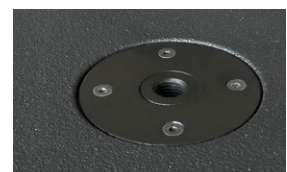

M20 flange on top.

## DIMENSIONS

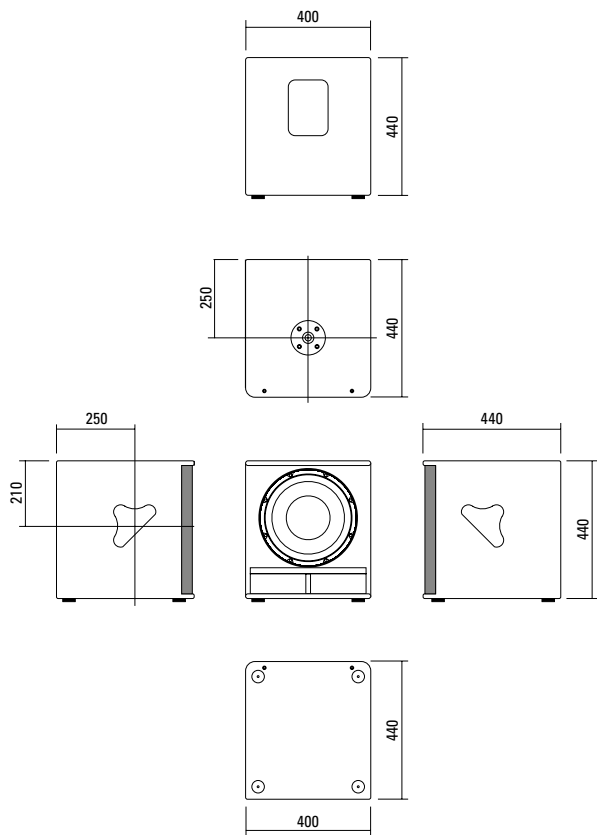

## MEASUREMENTS

### X-Over

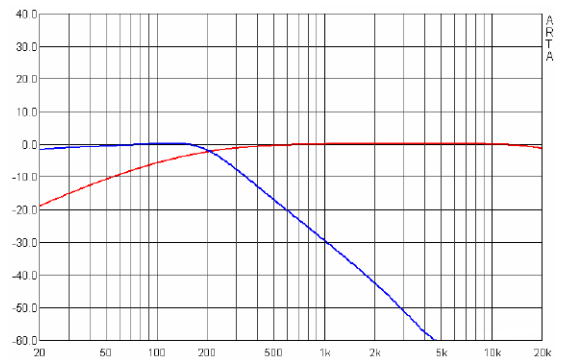

### Frequency Response

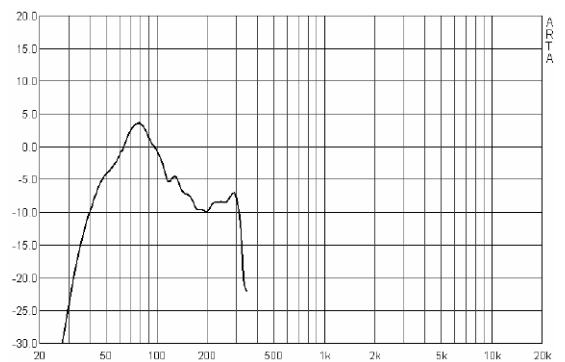

## SCHEMATIC CIRCUIT

Blockschaltbild  
TSMini Sub dp

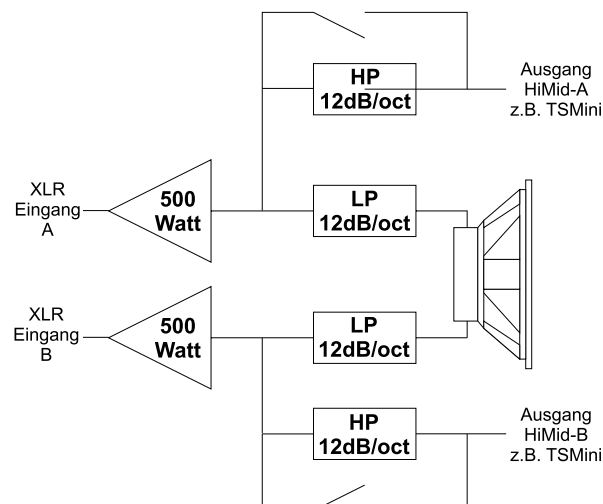

The TS Mini Sub dc dp features integrated digital amplifier electronics with a DSP controller. Various factory-configured presets and volume settings can be selected.

High-grade electronic components from the industrial sector and a first-class circuit design ensure excellent audio quality with low distortion and a minimal noise floor.

Highly efficient and "intelligent" limiter systems ensure optimum protection against overload, without restricting the possibilities offered by this high-performance sound system.

**Speakon NL4MP**

Outputs for the mid / high speakers

**Switch**

to activate or de-activate the internal passive crossover, depending on whether the application is as a stand-alone subwoofer or as part of a satellite system.

**XLR**

Symmetrical analog input.

**PowerCon (blue)**

Power supply  
195-250 VAC

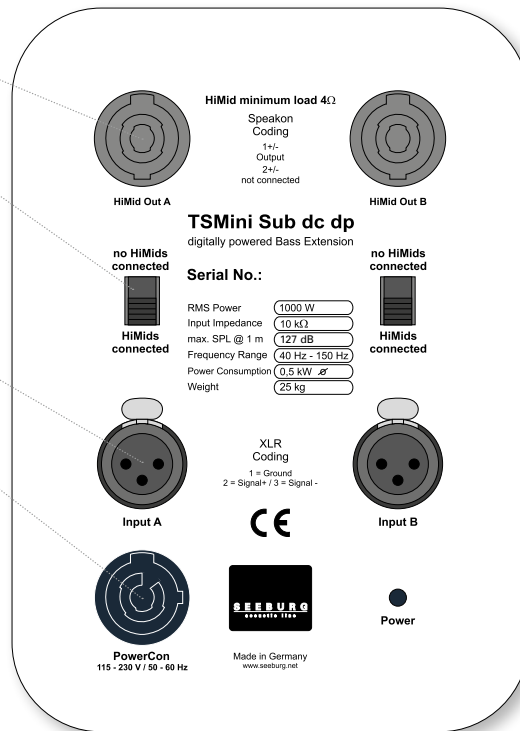

## ACCESSORIES TSMini Sub dc dp

### Speaker Pole

M20, with wind up, K&M

Order No. **03023**



M20, adjustable, K&M

Order No. **03022**



### Cover

for TSMini Sub

Order No. **01250**



### Flight Case

for 1 x TSMini Sub, heavy duty,  
6,5 mm birch multiplex, PVC coated,  
ball corners, recessed sprung handles,  
butterfly catches, rubber bases,  
interior lined with felt

Order No. **16053**

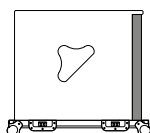
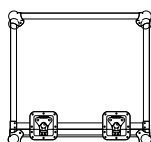

### Hybrid Cable System

PowerCon-PowerCon / XLR-XLR

2,5 m Order No. **08462**

5 m Order No. **08464**

10 m Order No. **08466**

15 m Order No. **08468**

