



The construction principle of the high powered K 30 mid-high cabinet allows for flexibility of use in horizontal or vertical orientations. Optimised placement of the 2 x 12" / 1.4" drivers in relation to one another ensures a very precise phase and coverage characteristic. For installation applications, the universal MultiRigg™ be used to mount the system. The K 30 is equipped with a passive crossover. Two different horn forms are available to better cover various sound reinforcement situations.

PRODUCT SPECIFICATIONS

Speaker Components	2 x 12" Nd (3,5" VC) / 1,4" Nd (3" VC)
Description	High Power HiMid System
Power AES / Peak	1300 W / 4000 W
Impedance nominal	4 Ω
SPL 1 W / Peak @ 1 m	101 dB / 137 dB
Usable Range	70 Hz - 18 kHz (-6 dB)
Tuning Frequency excursion minimum	80 Hz
X-Overpoint acoustical	750 Hz
Coverage horizontal / vertical	90° x 50° (60° x 50°), rotatable
Connectors	2 x Neutrik Speakon Coding: 1 +/- HiMid, 2 +/- thru
Handles	4 x
Rigging / Fittings	10 x M10 for MultiRigg™ 35 mm Pole Mount
Weight	32 kg
Size height x width x depth	77,0 x 36,0 x 46,0 cm
Order No.	01030/90° (90° x 50° Version) 01030/60° (60° x 50° Version)



60° Version



Einfache Installation mit dem universellen MultiRigg™.

DIMENSIONS

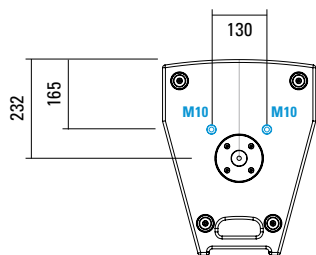

5 x M10 Twinpoints for MultiRigg™

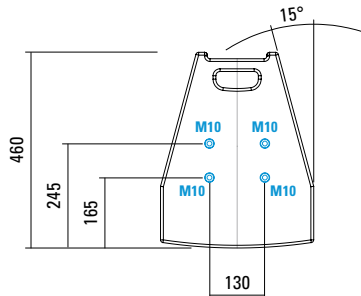
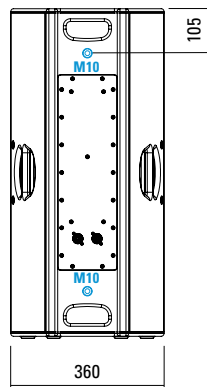
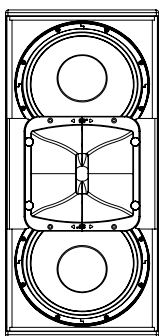
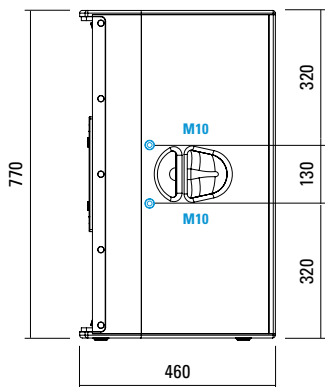

Controller Setups:

<https://www.seeburg.com/en/downloads>

K 30 xov - Sensitivity 1 W @ 1 m + Impedance

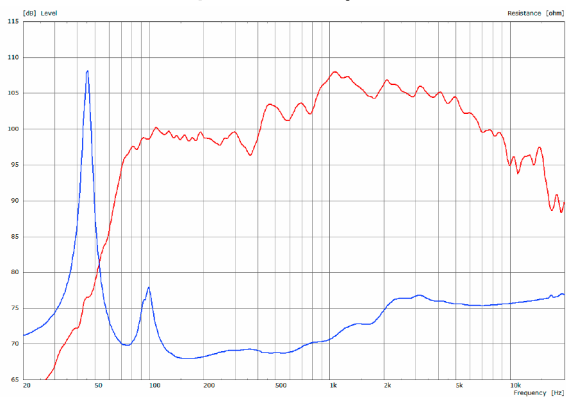

K 30 xov - Frequency Response with DSP Presets

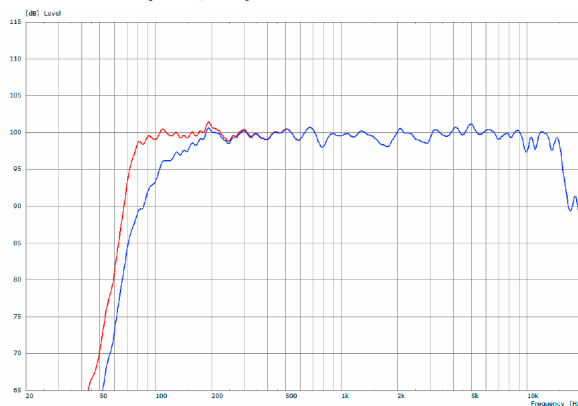

2D Directivity Plot - horizontal - 60° x 50°

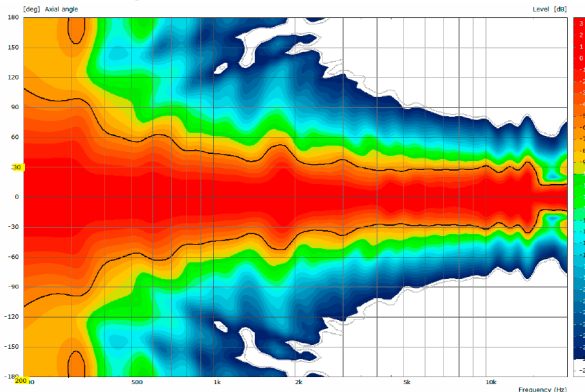

2D Directivity Plot - horizontal - 90° x 50°

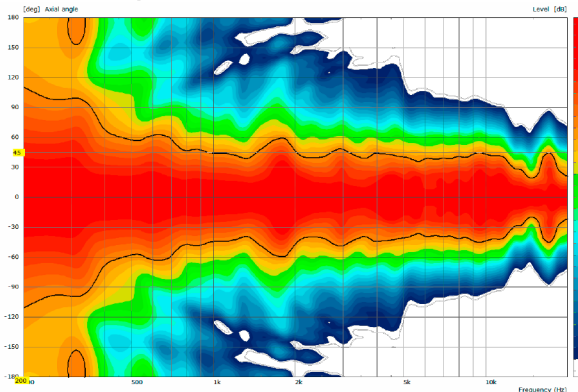

2D Directivity Plot - vertikal - 60° x 50°

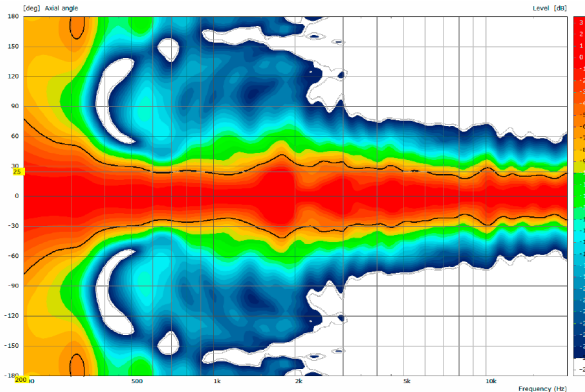

2D Directivity Plot - vertikal- 90° x 50°

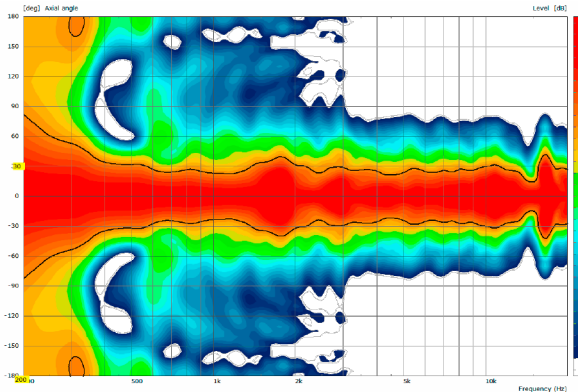

Flying Cradle



to fly one or two K 30 units,
for horizontal or vertical alignment,
(incl. load adapter M10, 4 x knurled
screws M10 x 20 mm)
Order No. **01353**

Connection Kit



to connect two K 30 units,
(6 x knurled screws M10 x 20 mm)
Order No. **08157/K30**

Knurled Screw



M10 x 20 mm
Order No. **73750/w** (RAL 9010)
Order No. **73750**

Knurled Head Nut



reduction screw for fastening
M10 Pole Mount Adapter (08126)
Order No. **73755**

Quick Trigger Clamp



max. load 100 kg
Order No. **01223/100 kg**

Steel Safety



8 mm x 600 mm,
max. load 40 kg (BGI 810-3),
quick connector undetachably
Order No. **01376/8**

Ring Screw



M10– DIN 580
Order No. **73700** (zincd)
Order No. **73700/sw** (black zincd)

TV Spigot



M10 internal thread,
28 mm Ø
Order No. **08128**

Pole Mount Adapter



35 mm ø → M10 x 16 mm,
M8 x 20 star knob screw
Order No. **08126**
Order No. **08126/w** (RAL 9010)

Pole Mount Adapter



35 mm ø → M10 x 16 mm
Order No. **08126/II**
Order No. **08126/II/w** (RAL 9010)

ACCESSORIES K 30

MultiRigg™



for flown and ground stacked applications, (incl. 2 x knurled screws M10 x 20 mm, 1 x handle screw M8 x 55 mm), max. load 50 kg
Order No. **01360**

MultiRigg™ Light



for fixed installations, (incl. 2 x socket head screws M10 x 20 mm), max. load 50 kg
Order No. **01362**

MultiRigg™ Basic



(incl. load adapter M10, 2 x knurled screws M10 x 20 mm), max. load: 50 kg
Order No. **01364**

MultiTilt™



Tilt adapter with adjustable tilt from 0° to 37,5° (2,5° steps), integr. pole mount adapter with clamping device, (incl. 2 x knurled screws M10 x 20 mm), max. load 50 kg
Order No. **01370**

MultiTilt™ Heavy Duty



for Galeo C / C-Series / K 24 / K 30, to be used with FD34 / FD33 truss, minimum truss length: 0,21 m consisting of base plate with M20 and tilt adjuster (incl. socket head screw M20 x 30 mm), weight: 13,5 kg, max. load 150 kg
Order No. **01359** (without traverse)

Wall Mount



bar: 269 mm, (incl. socket head screw M10 x 70 mm, hex lock nut and flat washer M10), max. load 40 kg
Order No. **08130/F/269/w** (RAL 9010)
Order No. **08130/F/269**

Wall Mount



bar: 400 mm, (incl. socket head screw M10 x 70, hex lock nut and flat washer M10), max. load 40 kg
Order No. **08130/F400/w** (RAL 9010)
Order No. **08130/F400**

Bag



for 1 x K 30, with two-way zip, padded, incl. label pocket
Order No. **01234/K30**

Flight Case



for 2 pcs. K 30, mounting option for MultiRigg / MultiTilt in the lid, partition wall, interior lined with felt, PVC coated black, 4 x stacking recesses, 4 x 100 mm blue wheels (2 pcs. with brake)
Size: 80 x 84 x 66 cm (W x D x H), 37 kg
Order No. **16032**

